

► **Code Number**

3080053

► **Description**

Exposed Water Closet Flushometer, for floor mounted or wall hung top spud bowls.

► **Flush Cycle**

Model 111 Low Consumption (1.6 gpf/6.0 Lpf)

► **Specifications**

Quiet, Exposed, Diaphragm Type, Chrome Plated Closet Flushometer with the following features:

- ADA Compliant Metal Oscillating Non-Hold-Open Handle
- 1" I.P.S. Screwdriver Bak-Chek® Angle Stop
- Control Stop Plug
- Sweat Solder Adapter with Cover Tube
- Cast Wall Flange with Set Screw
- Vacuum Breaker Flush Connection
- Spud Coupling and Spud Flange for 1½" Top Spud
- High Copper, Low Zinc Brass Castings for Dezincification Resistance
- Non-Hold-Open Handle and No External Volume Adjustment to Ensure Water Conservation
- Low Consumption flush accuracy controlled by Para-Flo™ Technology

Valve Body, Cover and Tailpiece shall be in conformance with ASTM Alloy Classification for Semi-Red Brass. Valve shall be in compliance to the applicable sections of ASSE 1037.

► **Accessories**

See Accessories Section of the Sloan catalog for details on these and other Flushometer variations.

► **Fixtures**

Consult factory to match Sloan fixture options.

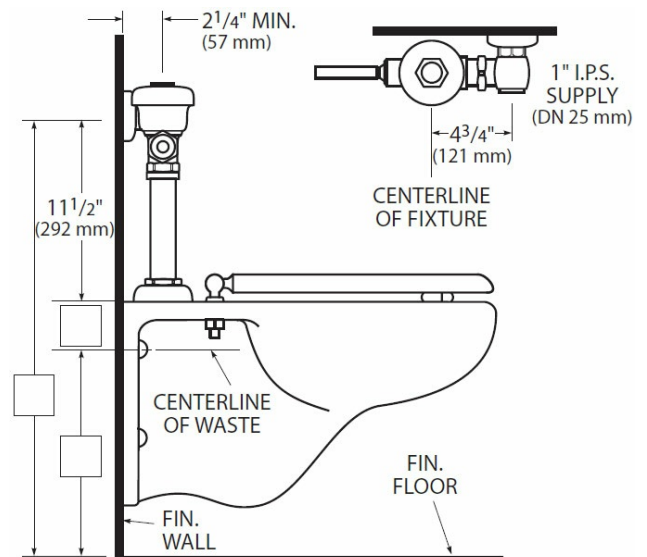

► **Compliance**



This space for Architect/Engineer Approval